

20.68.1009.00

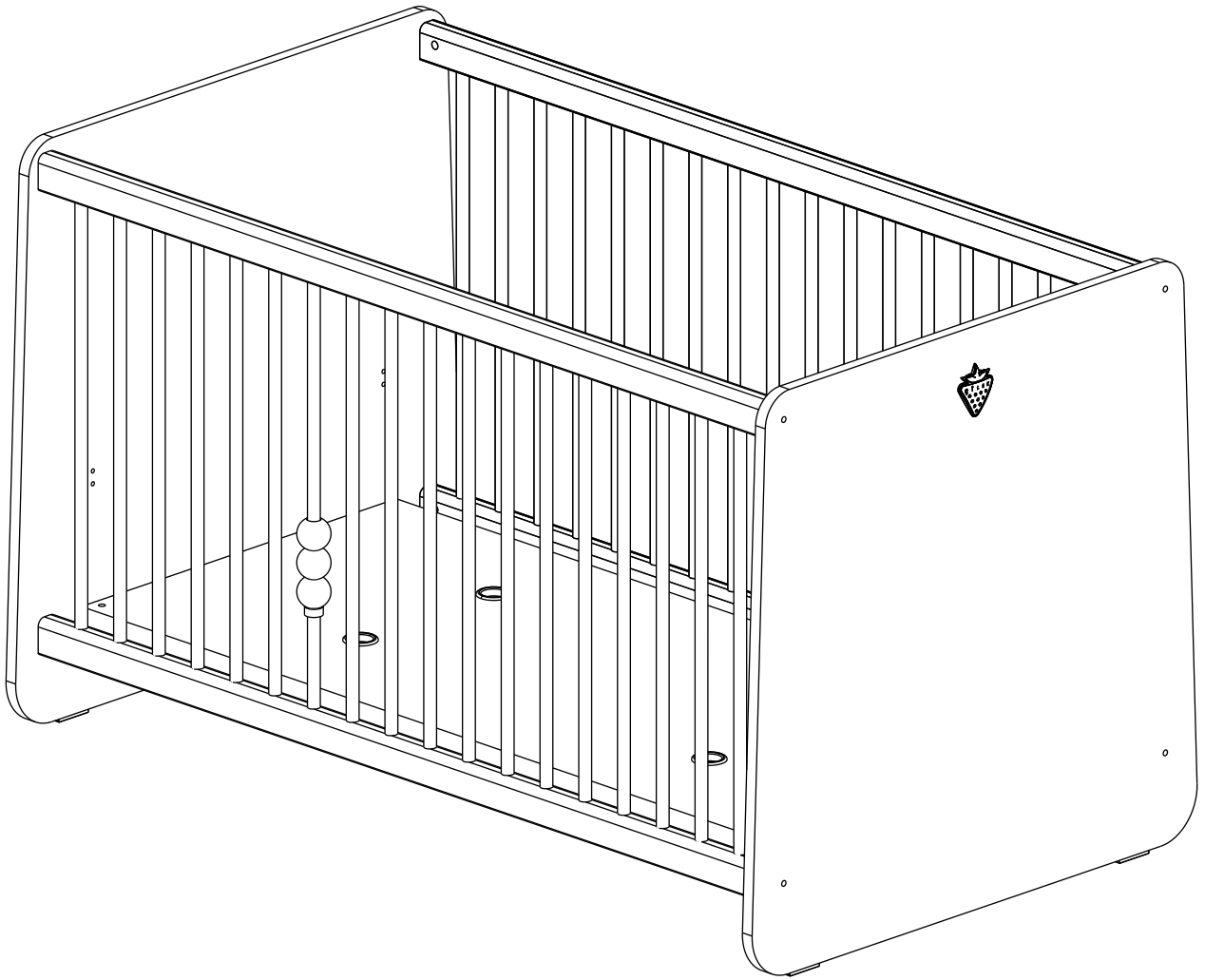

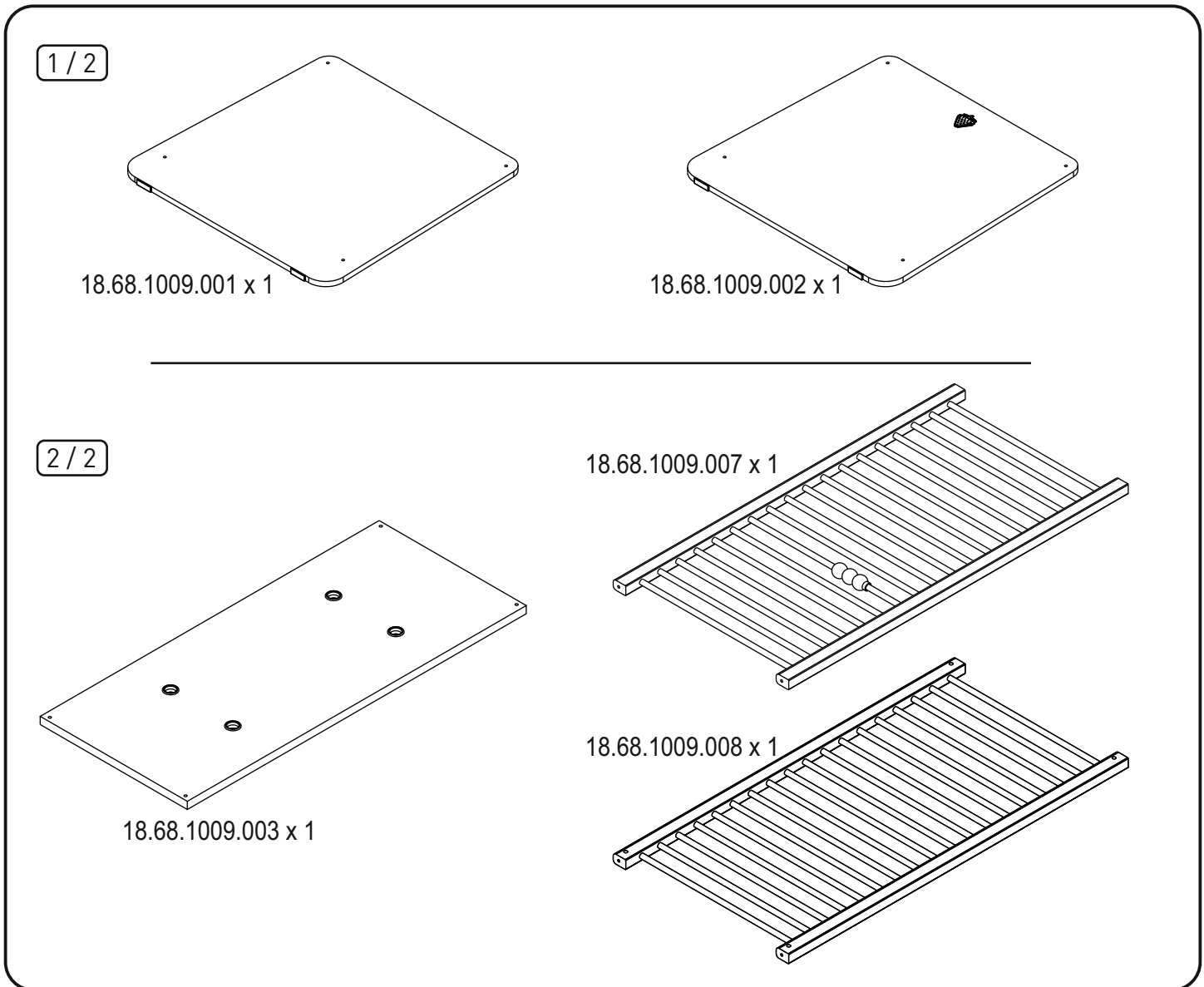

1

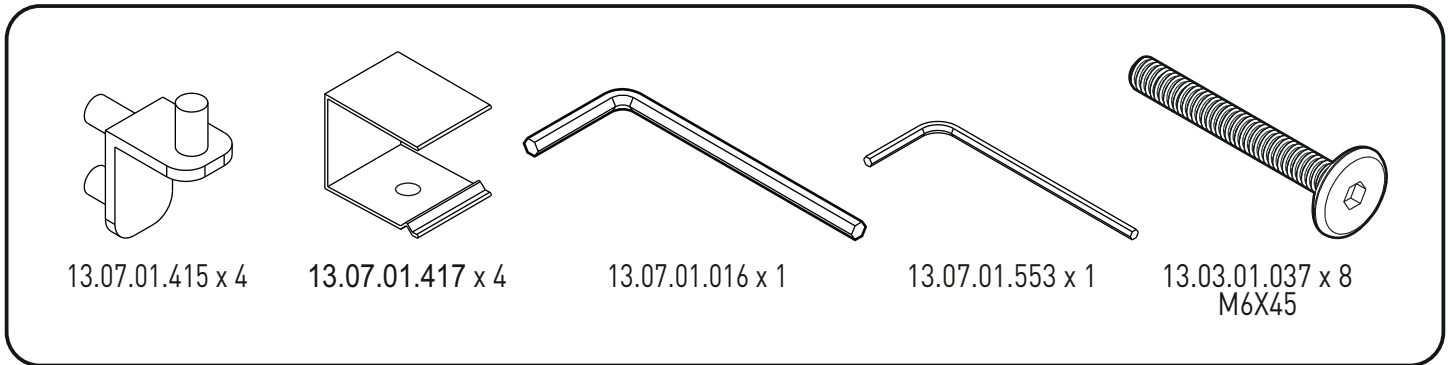
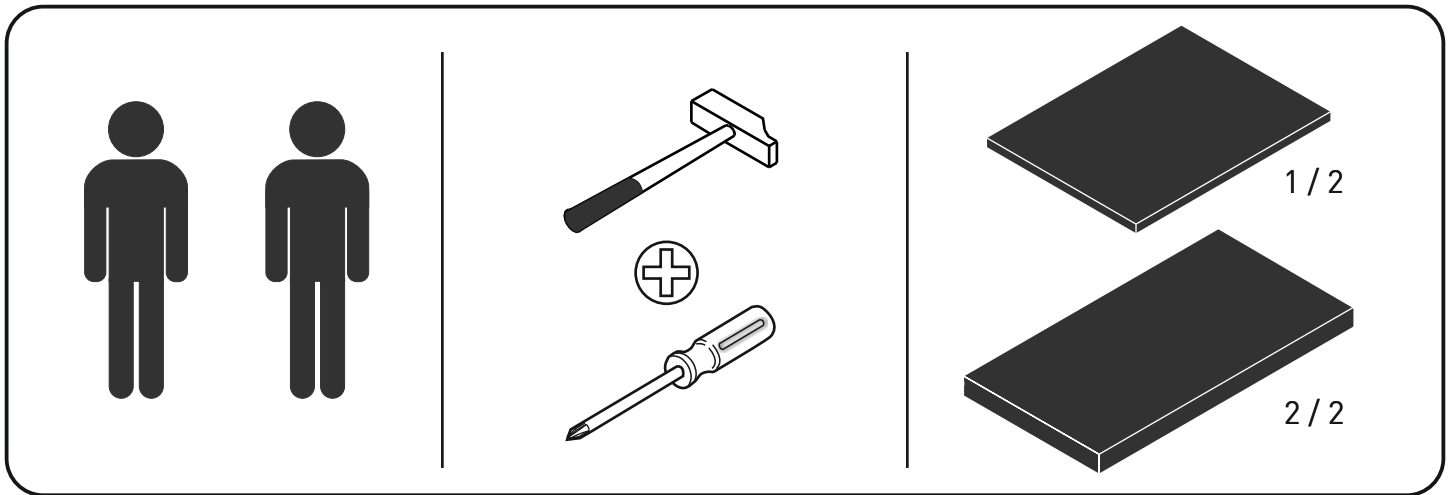
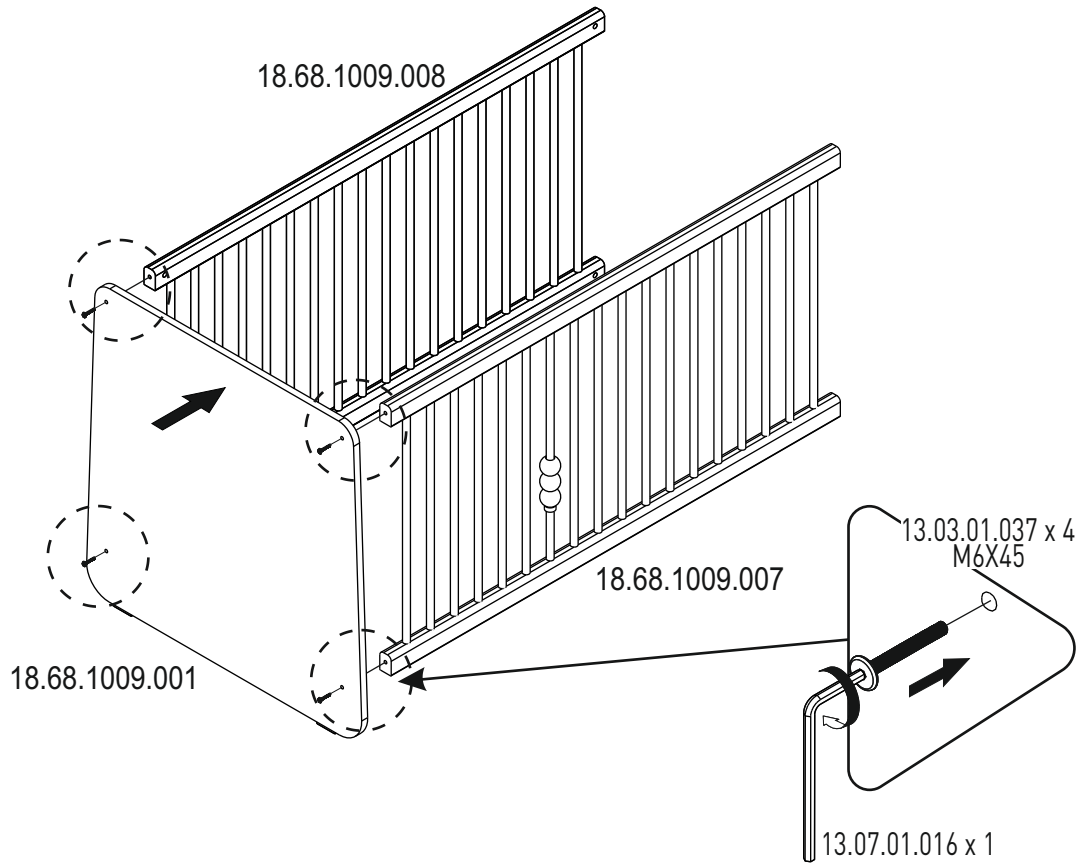

2

